

KES (runder Deckel)
3.50/1.50/2.00 (ohne Einmündungstrichter)
Schalung

NZ_B_034

Massstab : 1:50 / 1:20	Datum : Sept. 2010
Bearbeitet : EM	Gesehen : CR

 LIEFERUNG BAUSEITS

zulässige Belastung:
 ca. 40cm überdeckt
 Radlast 150 kN

Längsschnitt 1:50

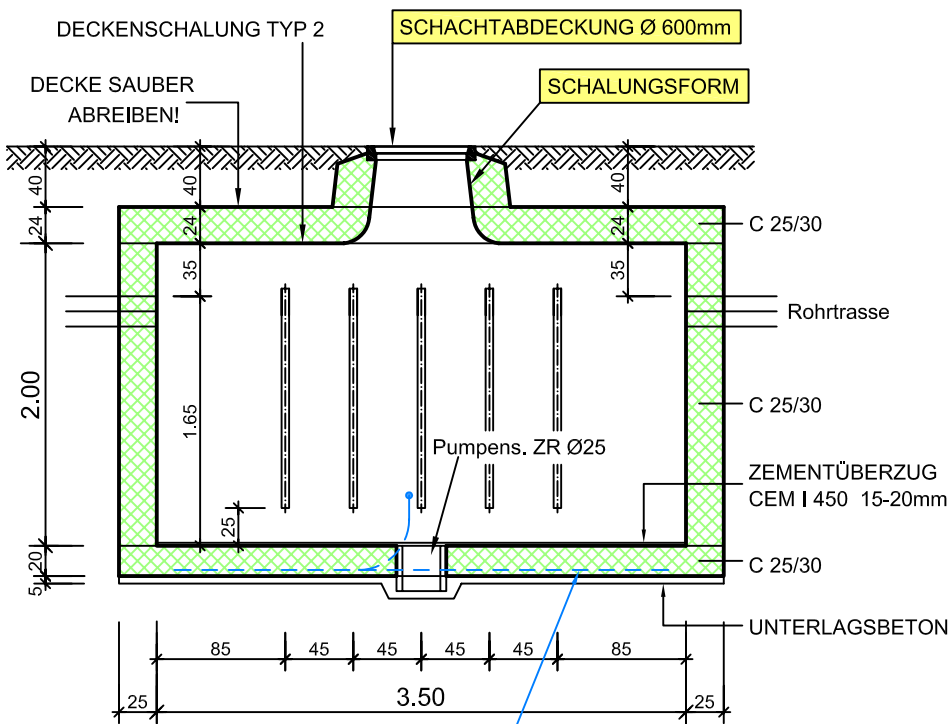

Einlage Erdungsseil gem. Plan NZ_B_043

Querschnitt 1:50

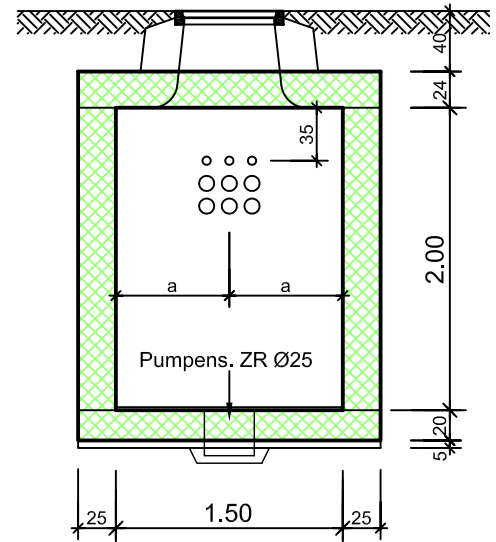

Grundriss 1:50

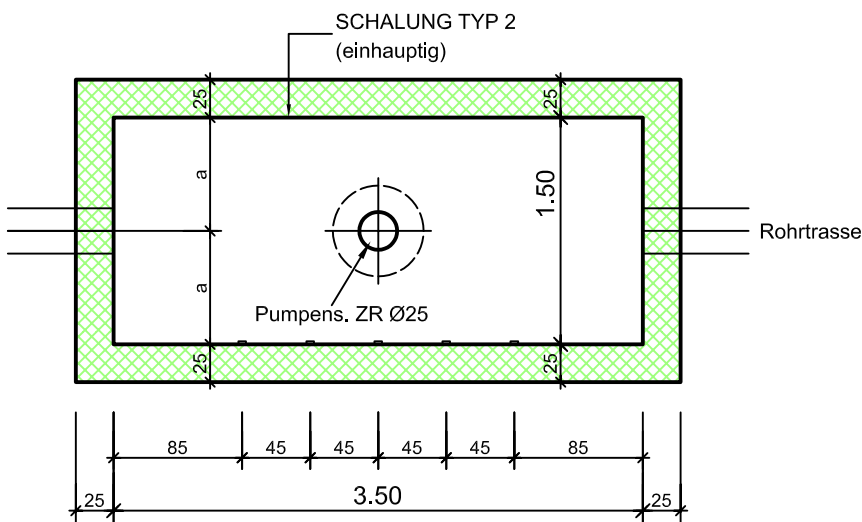

Schnittdetail 1:20

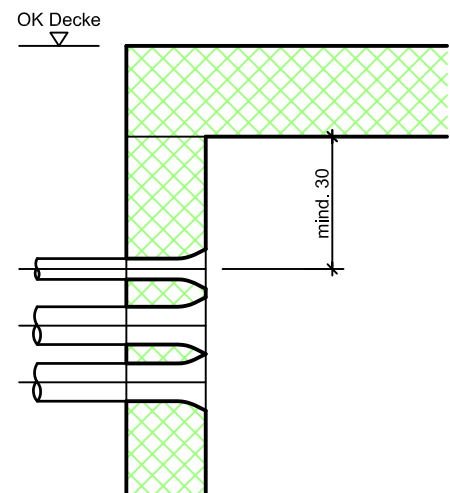

KES (runder Deckel)
 3.50/1.50/2.00 (ohne Einmündungstrichter)
 Armierung

NZ_B_034

Massstab :	Datum :
1:50 / 1:25	Sept. 2010
Bearbeitet :	Gesehen :
EM	CR

Grundriss 1:50
 Armierung Boden

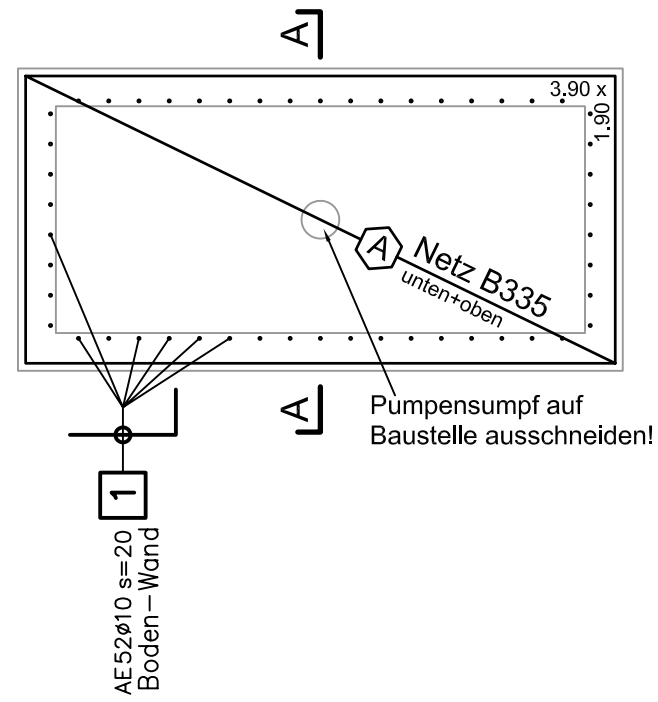

Grundriss 1:50
 Armierung Wände

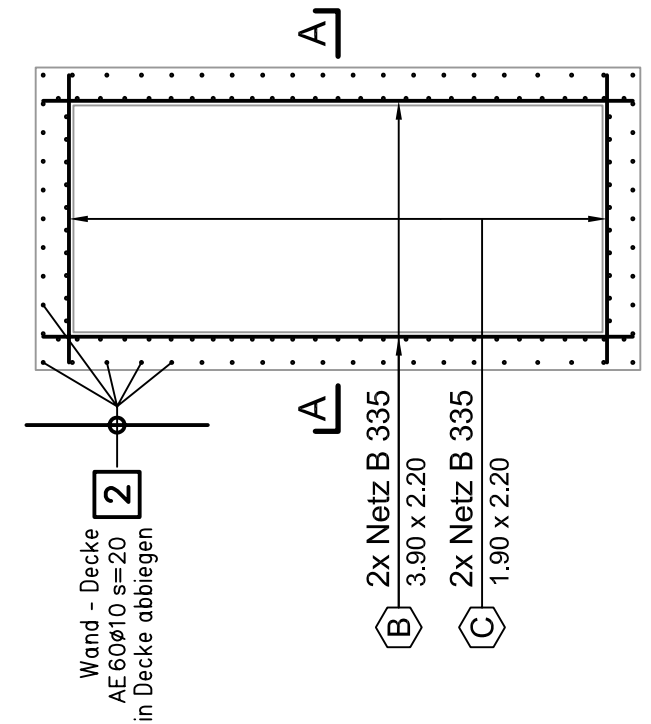

Grundriss 1:25
 Armierung Decke

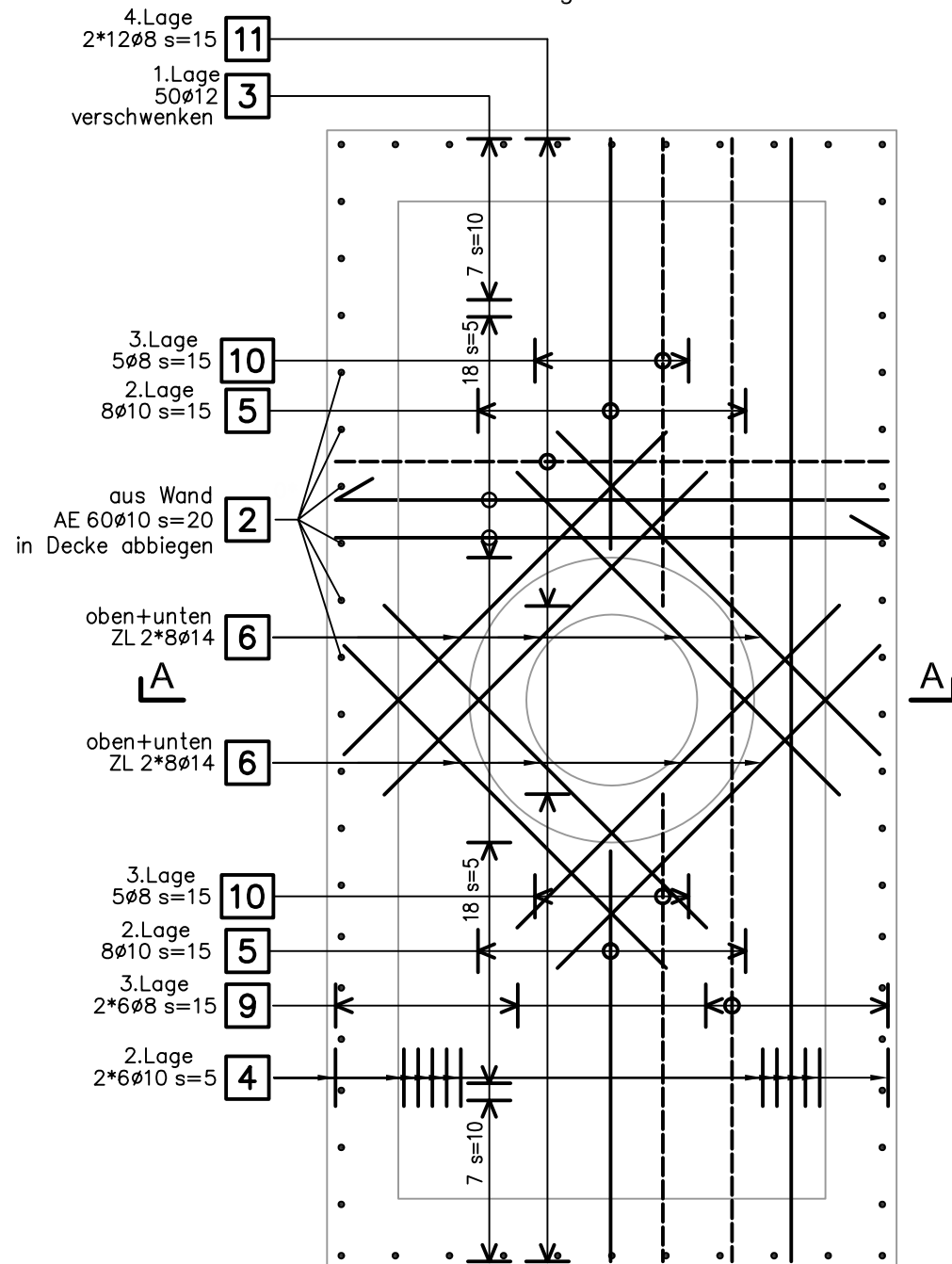

3cm Eisenüberdeckung

Lagerlängen 12 1Ø8

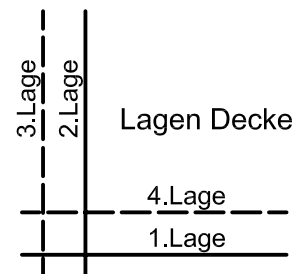

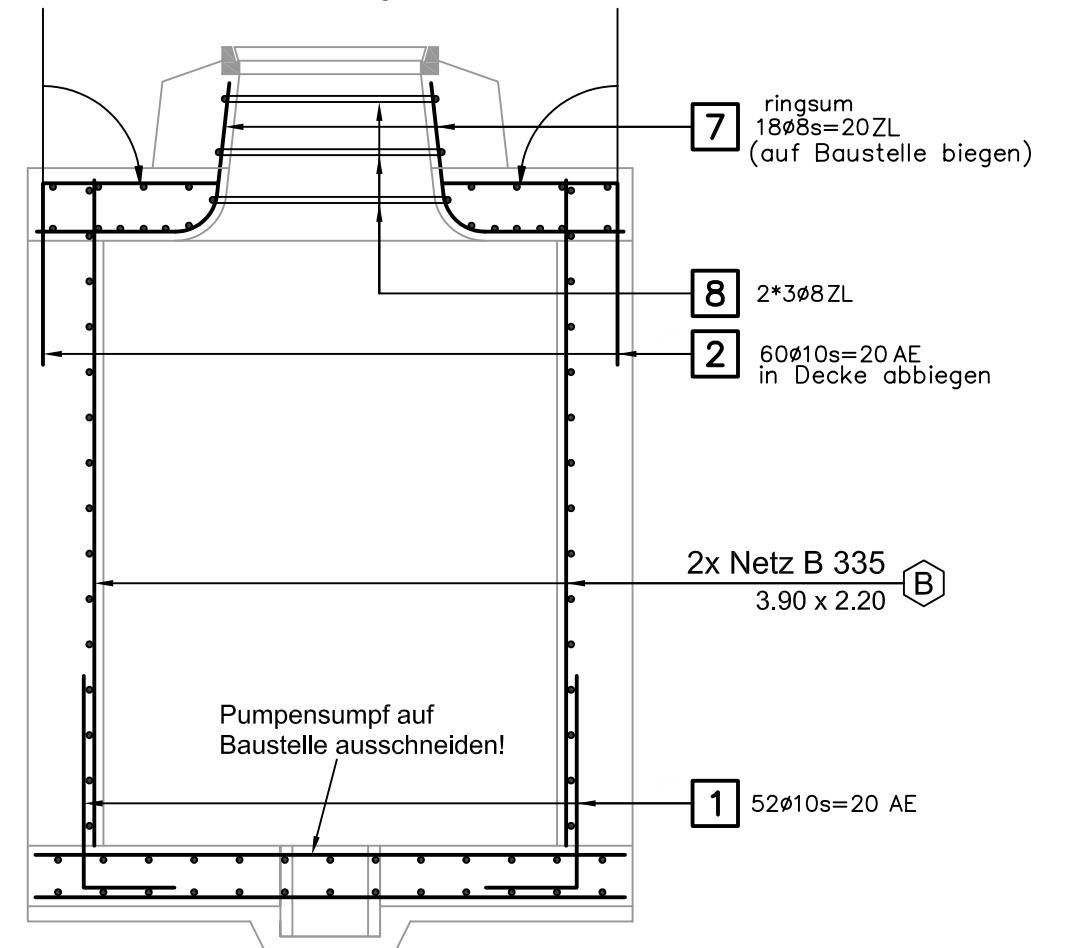

Schnitt A - A 1:25
 Armierung



BAUOBJEKT	Liechtensteinische Kraftwerke Im alten Riet 17, FL-9494 Schaan Tel. +423 236 01 11, Fax +423 236 01 12 lkW@lkW.li, www.lkW.li		BETONSTAHLLISTE NR. NZ_B_034_EL						
	KES 3.50/1.50/2.00	ZU PLAN NR. NZ_B_034	<table border="1" style="width: 100%; border-collapse: collapse;"> <tr> <td style="width: 30%;">Datum</td> <td style="width: 40%;">Sept. 2010</td> <td style="width: 30%;">Gepr.</td> </tr> <tr> <td>Gez.</td> <td>EM</td> <td>Rev.</td> </tr> </table>		Datum	Sept. 2010	Gepr.	Gez.	EM
Datum	Sept. 2010	Gepr.							
Gez.	EM	Rev.							
BAUUNT.			BETONSTAHL GEMÄSS SIA-NORM 262 ERGÄNZUNG 262/1						
INGENIEUR	Wenaweser+Partner Bauingenieure AG		Büro Schaan, Schmedgässle 2, FL-9494 Schaan Tel: +423 237 50 80 / Fax: +423 237 50 81 Büro Ruggell, Noflerstrasse 12, FL-9491 Ruggell Tel: +423 370 18 90 / Fax: +423 370 18 94						
	info@bauingenieure.li www.bauingenieure.li								

ZUSAMMENFASSUNG B500B								
Anzahl Pos.	Fix- und Lagerlängen		Gewicht kg	Meter-Gewicht kg/m	Durchmesser mm	Anzahl Pos.	Bearbeitet	
	Länge m	Länge m					Länge m	Gewicht kg
5	158.24		62.505	0.395	8	1	9.78	3.863
3	142.32		87.811	0.617	10	1	52.00	32.084
1	51.20		61.952	0.888	12	1	104.50	92.796
1				1.210	14			
9	Gesamt		212.268			3	Gesamt 128.743	
GESAMTMENGE								341.011

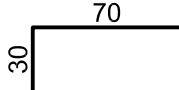
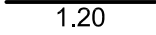
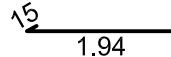
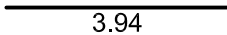
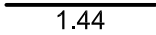
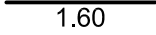
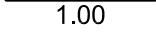
Abstandhalter				Stützbügel	
Typ	Stückzahl	Länge Total m	Höhe cm	Stückzahl	Höhe cm
DISTANZKORB-H90MM-OHNE-FUSS	4	10.00	9.0		

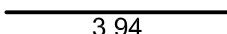
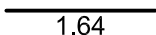
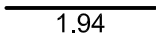
Pos.	Stk.	d	Länge	Ges.L	Gewicht kg	Biegeform
1	52	10	1.00	52.00	32.084	
2	60	10	1.20	72.00	44.424	
3	50	12	2.09	104.50	92.796	
4	12	10	3.94	47.28	29.172	
5	16	10	1.44	23.04	14.216	
6	32	14	1.60	51.20	61.952	
7	18	8	1.00	18.00	7.110	
8	6	8	1.63	9.78	3.863	 <div style="display: inline-block; vertical-align: middle; margin-left: 20px;"> $\frac{l}{1.63} > \frac{275}{8} \frac{r}{0.34}$ </div>
9	12	8	3.94	47.28	18.676	
10	10	8	1.64	16.40	6.478	
11	24	8	1.94	46.56	18.391	
12	lfdm	8	30	30.00	11.850	

NETZLISTE

Objekt: **Liechtensteinische Kraftwerke**
 Im alten Riet 17, FL-9494 Schaan
 Tel. +423 236 01 11, Fax +423 236 01 12
 lkw@lkw.li, www.lkw.li



Trennplan Nr.: **NZ_B_034_NL**

zu Verlegeplan Nr.: **NZ_B_034**

Bauteil: **KES 3.50/1.50/2.00**

Datum: **Sept. 2010** gez: **EM** kontr.:

Ingenieur: **Wenaweser + Partner AG**

Unternehmer:

Schmedgässle 2

FL-9494 Schaan

Liefertermin:

Bemerkung:

Lieferung mit Kranwagen ja nein

Typ **B 335.39**
2 Stück

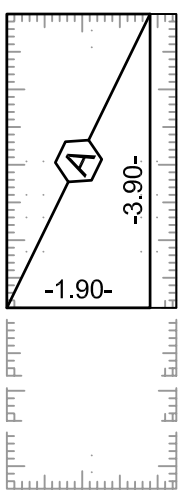

Typ **B 335.63**
2 Stück

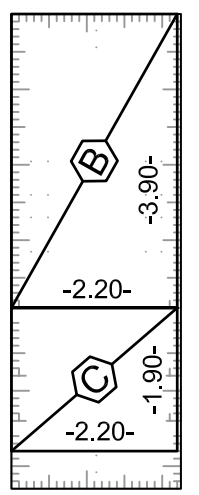

Typ
..... Stück

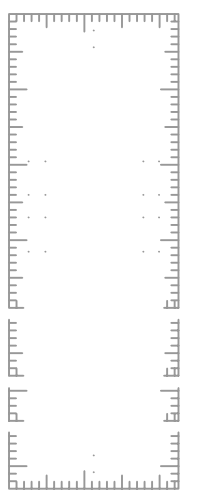

Typ
..... Stück

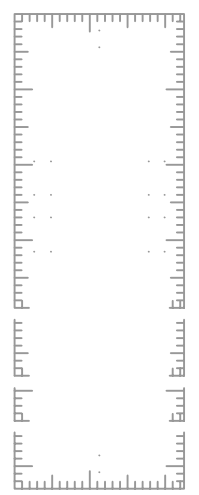

Lagermatten

nach Trennplan bearbeitet
 unbearbeitet

Typ	Stück	Gewicht kg
B 335.39	2	93.8
B 335.63	2	151.4
Total Gewicht kg		245.2
Anzahl Mattenpos.		3

Typ
..... Stück

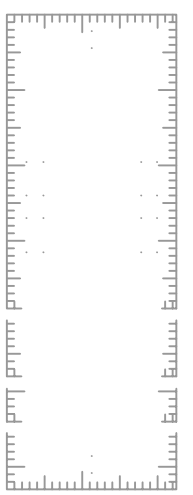

Typ
..... Stück

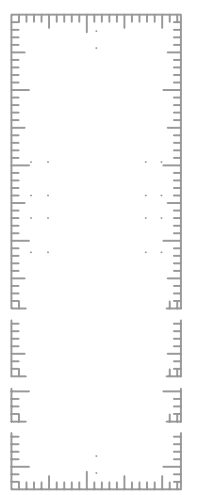

Typ
..... Stück

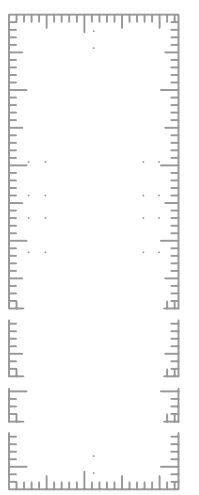

Typ
..... Stück

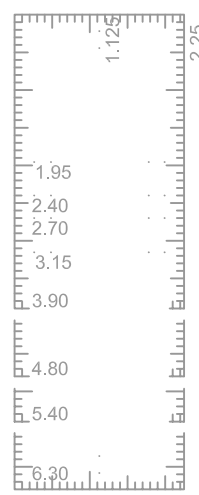

Distanzkörbe

mit oder ohne Kunststoff-Fuss
 Länge 2.50m Bunde à 10Stück

Höhe mm	Stück	m	mit	ohne
			<input type="checkbox"/>	<input type="checkbox"/>
			<input type="checkbox"/>	<input type="checkbox"/>
			<input type="checkbox"/>	<input type="checkbox"/>
			<input type="checkbox"/>	<input type="checkbox"/>

Anschlusskörbe AU forwa®

Länge 3.04m

Typ	Stück	m

Anschlusskörbe FIRIPA®

Länge 3.00m

Typ	Stück	m