

**KES** (runder Deckel)  
**3.50/2.00/2.00** (ohne Einmündungstrichter)  
**Schalung**

**NZ\_B\_035**

Massstab : 1:50 / 1:20	Datum : Sept. 2010
Bearbeitet : EM	Gesehen : CR

 LIEFERUNG BAUSEITS

**zulässige Belastung:**

ca. 40cm überdeckt  
 Radlast 150 kN

**Längsschnitt 1:50**

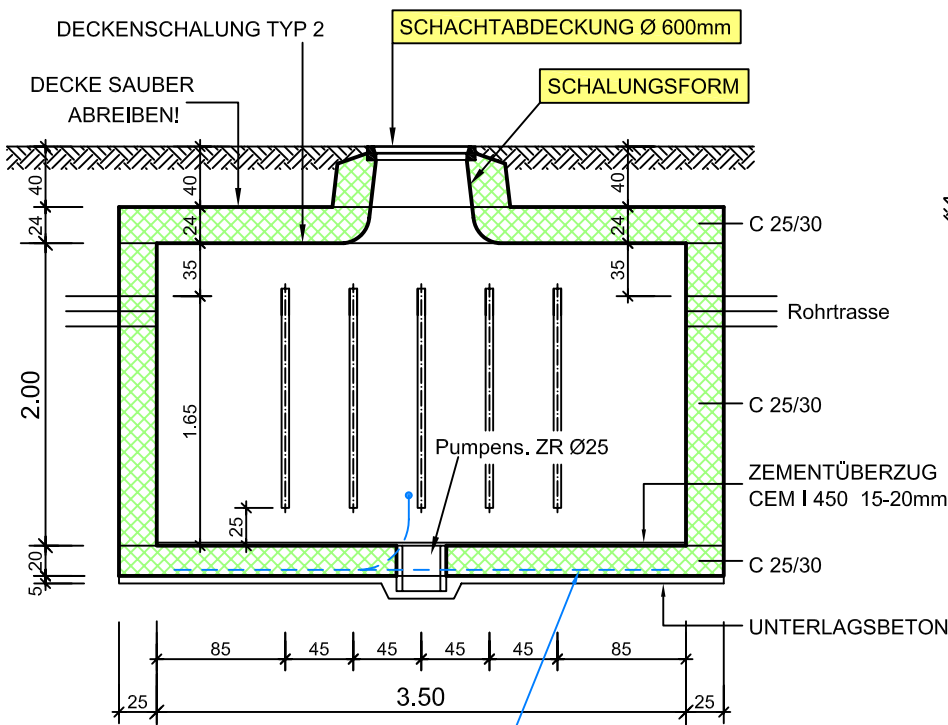

Einlage Erdungsseil gem. Plan NZ\_B\_043

**Querschnitt 1:50**

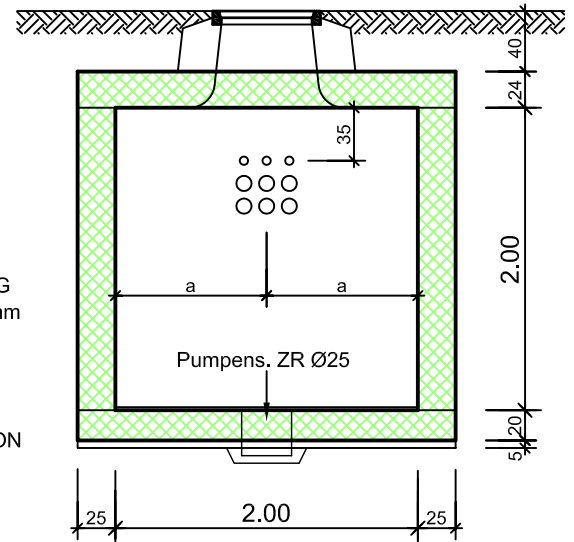

**Grundriss 1:50**

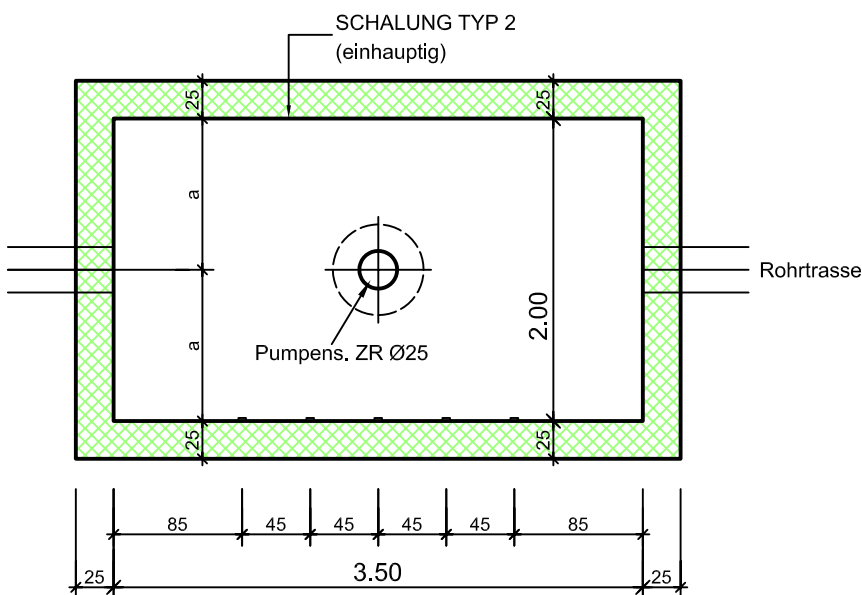

**Schnittdetail 1:20**

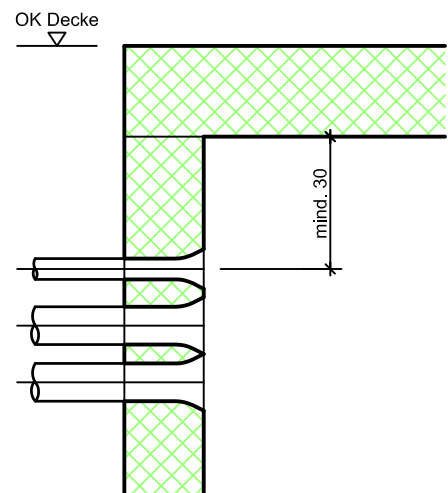

**KES** (runder Deckel)  
 3.50/2.00/2.00 (ohne Einmündungstrichter)  
 Armierung

**NZ\_B\_035**

Massstab : 1:50 / 1:25	Datum : Sept. 2010
Bearbeitet : EM	Gesehen : CR

**Grundriss 1:50**  
 Armierung Boden

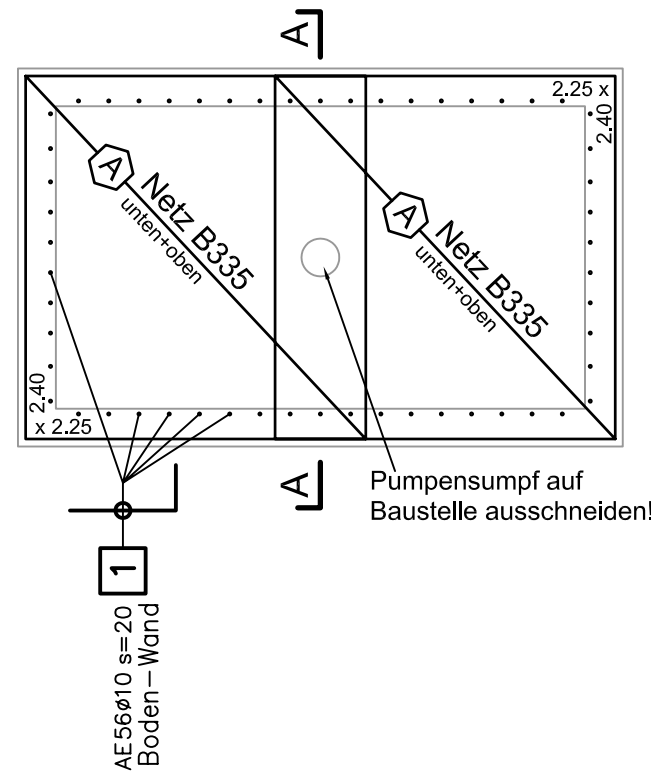

**Grundriss 1:50**  
 Armierung Wände

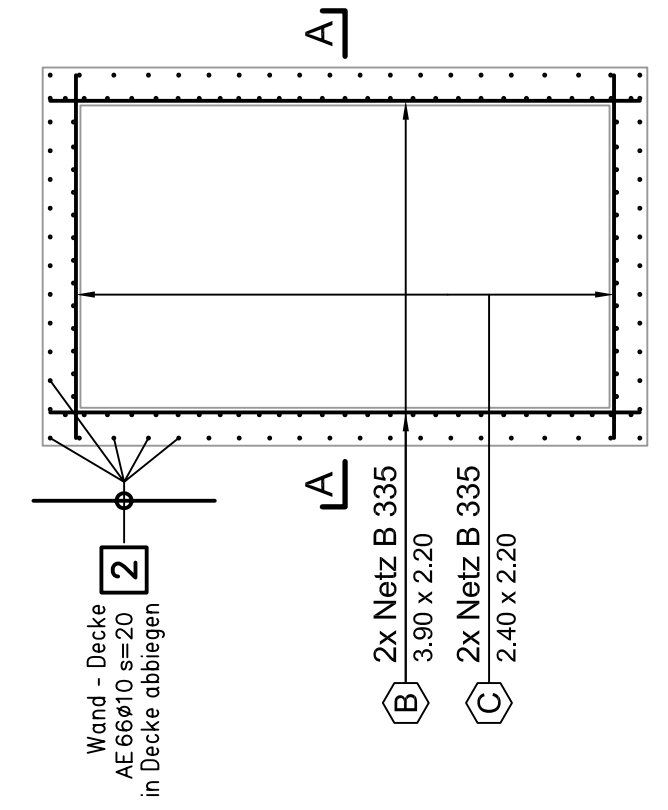

**Grundriss 1:25**  
 Armierung Decke

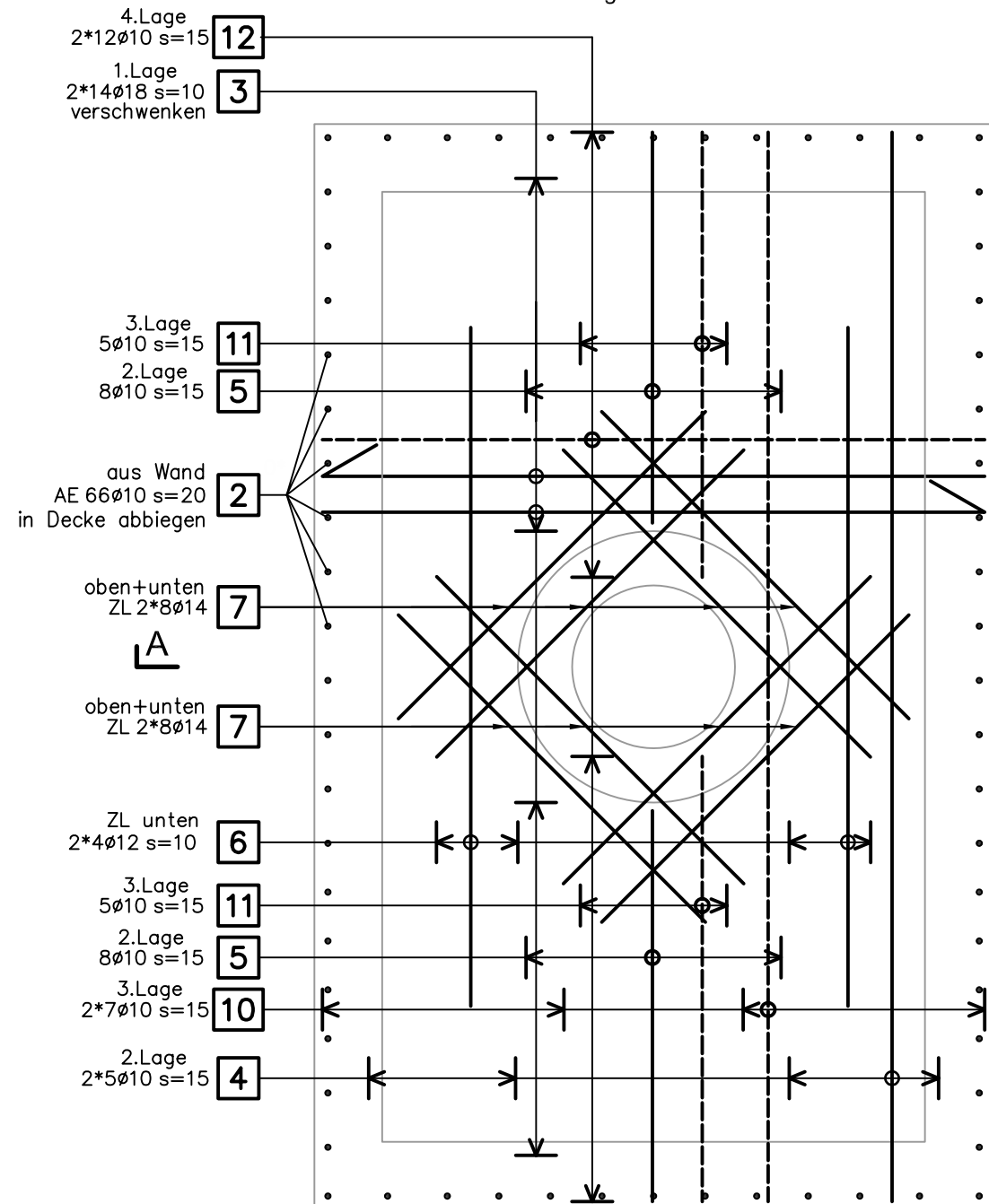

**3cm Eisenüberdeckung**

Lagerlängen **13** 1φ8

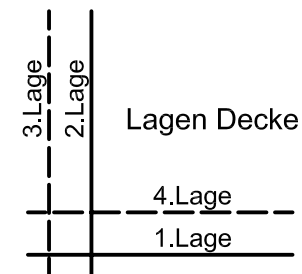



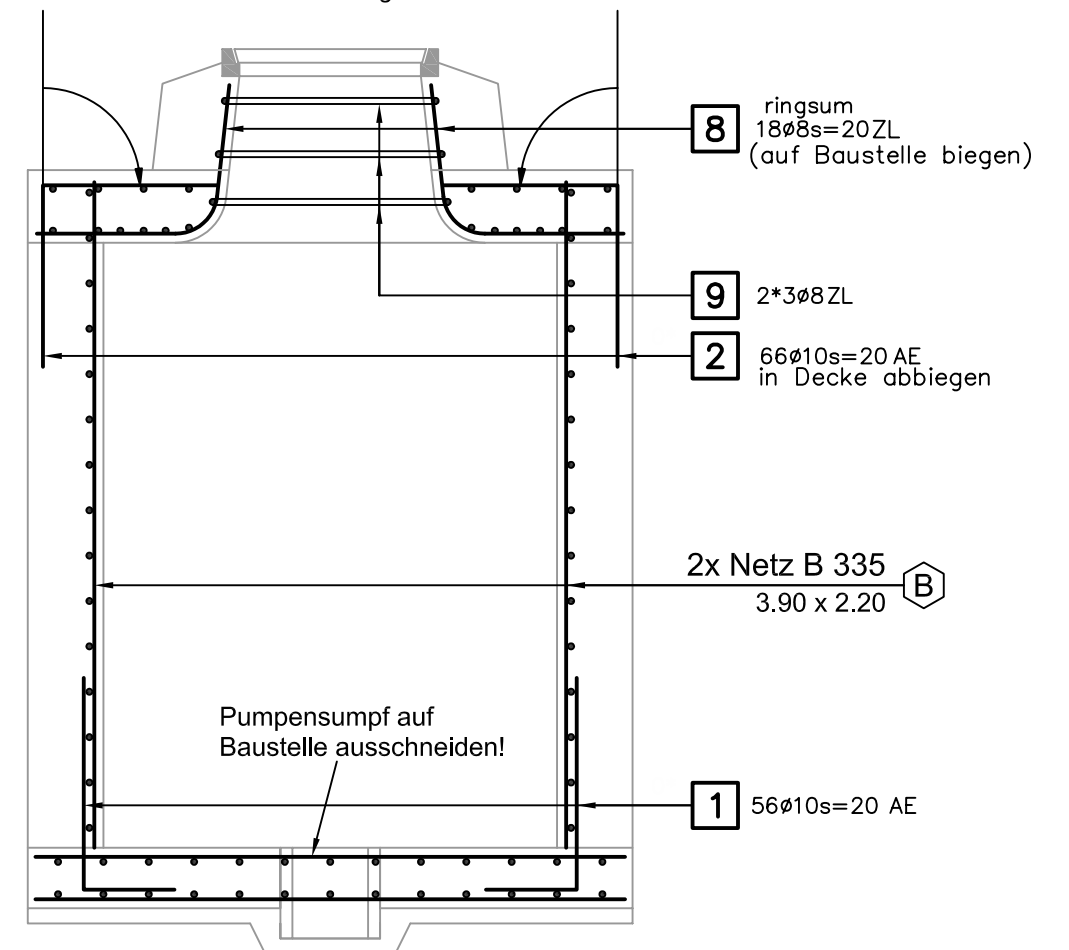





**Schnitt A - A 1:25**  
 Armierung

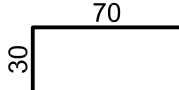
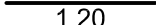
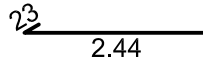
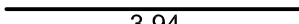

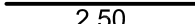
BAUOBJEKT	<b>Liechtensteinische Kraftwerke</b> Im alten Riet 17, FL-9494 Schaan Tel. +423 236 01 11, Fax +423 236 01 12 lkww@lkww.li, www.lkww.li		BETONSTAHLLISTE NR. <b>NZ_B_035_EL</b>	
	<b>KES</b> <b>3.50/2.00/2.00</b>		ZU PLAN NR. <b>NZ_B_035</b>	
BAUUNT.			Datum Sept. 2010	Gepr. 
			Gez. EM	Rev. 
INGENIEUR	<b>Wenaweser+Partner</b> Bauingenieure AG		Büro Schaan, Schmedgässle 2, FL-9494 Schaan Tel: +423 237 50 80 / Fax: +423 237 50 81	
			Büro Ruggell, Noflerstrasse 12, FL-9491 Ruggell Tel: +423 370 18 90 / Fax: +423 370 18 94	
		info@bauingenieure.li www.bauingenieure.li		

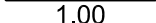
ZUSAMMENFASSUNG B500B								
Anzahl Pos.	Fix- und Lagerlängen		Meter-Gewicht kg/m	Durchmesser mm	Anzahl Pos.	Bearbeitet		
	Länge m	Gewicht kg				Länge m	Gewicht kg	
2	48.00	18.960	0.395	8	1	9.78	3.863	
6	271.76	167.676	0.617	10	1	56.00	34.552	
1	20.00	17.760	0.888	12				
1	51.20	61.952	1.210	14				
			2.000	18	1	74.76	149.520	
10	Gesamt	266.348			3	Gesamt	187.935	
<b>GESAMTMENGE</b>							<b>454.283</b>	

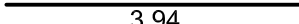
Abstandhalter				Stützbügel	
Typ	Stückzahl	Länge Total m	Höhe cm	Stückzahl	Höhe cm
DISTANZKORB-H90MM-OHNE-FUSS	4	10.00	9.0		

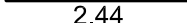
Pos.	Stk.	d	Länge	Ges.L	Gewicht kg	Biegeform
1	56	10	1.00	56.00	34.552	
2	66	10	1.20	79.20	48.866	
3	28	18	2.67	74.76	149.520	
4	10	10	3.94	39.40	24.310	
5	16	10	1.44	23.04	14.216	
6	8	12	2.50	20.00	17.760	
7	32	14	1.60	51.20	61.952	
8	18	8	1.00	18.00	7.110	
9	6	8	1.63	9.78	3.863	 <div style="display: inline-block; vertical-align: middle; margin-left: 20px;"> <math>\frac{l}{1.63} &gt; 275</math>  <math>r = 0.34</math> </div>
10	14	10	3.94	55.16	34.034	
11	10	10	1.64	16.40	10.119	
12	24	10	2.44	58.56	36.132	
13	lfdm	8	30	30.00	11.850	

# NETZLISTE

Objekt: **Liechtensteinische Kraftwerke**  
 Im alten Riet 17, FL-9494 Schaan  
 Tel. +423 236 01 11, Fax +423 236 01 12  
 lk@lkw.li, www.lkw.li

Bauteil: **KES 3.50/2.00/2.00**

Ingenieur: **Wenaweser + Partner AG**  
 Schmedgässle 2  
 FL-9494 Schaan



Trennplan Nr.: **NZ\_B\_035\_NL**

zu Verlegeplan Nr.: **NZ\_B\_035**

Datum: **Sept. 2010** gez: **EM** kontr.:

Unternehmer:

Liefertermin:

Lieferung mit Kranwagen  ja  nein

Bemerkung:

Typ **B 335.48**  
2 Stück

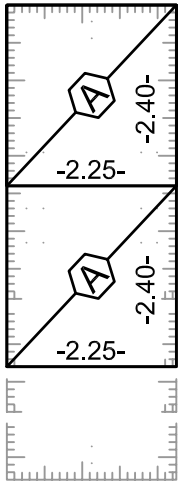

Typ **B 335.63**  
2 Stück

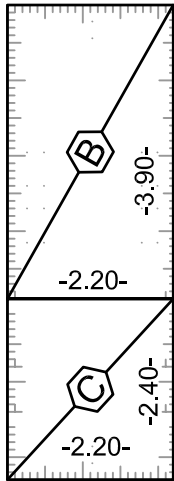

Typ .....  
..... Stück

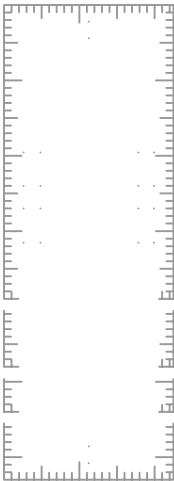

Typ .....  
..... Stück

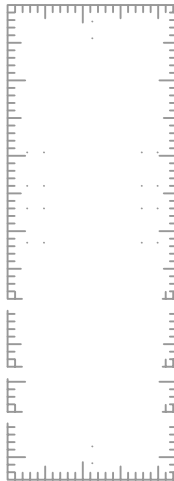

### Lagermatten

nach Trennplan bearbeitet  
 unbearbeitet

Typ	Stück	Gewicht kg
B 335.48	2	115.4
B 335.63	2	151.4

Total Gewicht kg **266.8**

Anzahl Mattenpos. **3**

Typ .....  
..... Stück

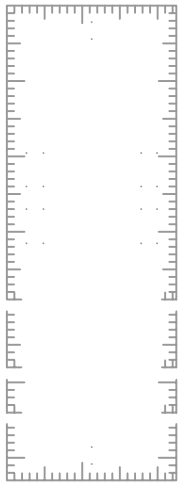

Typ .....  
..... Stück

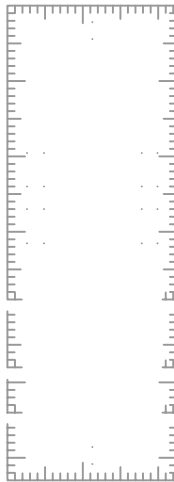

Typ .....  
..... Stück

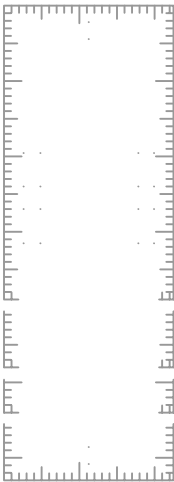

Typ .....  
..... Stück

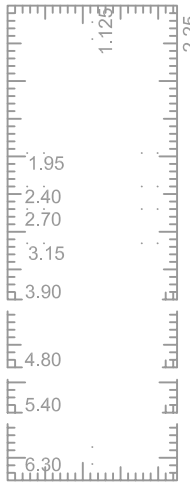

### Distanzkörbe

mit oder ohne Kunststoff-Fuss  
 Länge 2.50m Bunde à 10Stück

Höhe mm	Stück	m	mit	ohne
			<input type="checkbox"/>	<input type="checkbox"/>
			<input type="checkbox"/>	<input type="checkbox"/>
			<input type="checkbox"/>	<input type="checkbox"/>
			<input type="checkbox"/>	<input type="checkbox"/>

### Anschlusskörbe AU forwa®

Länge 3.04m

Typ	Stück	m

### Anschlusskörbe FIRIPA®

Länge 3.00m

Typ	Stück	m